



CLOUDRAY SERIES

AC INFINITY

WELCOME

Thank you for choosing AC Infinity. We are committed to product quality and friendly customer service. If you have any questions or suggestions, please don't hesitate to [contact](#) us. Visit www.acinfinity.com and click contact for our contact information.

EMAIL

support@acinfinity.com

WEB

www.acinfinity.com

LOCATION

Los Angeles, CA

MANUAL CODE CR2403X1

PRODUCT

CLOUDRAY A6
CLOUDRAY A9
CLOUDRAY S6
CLOUDRAY S9
CLOUDRAY S6, 2 Pack

MODEL

AC-CCA6
AC-CCA9
AC-CCS6
AC-CCS9
AC-CCX6

UPC-A

819137022416
819137022454
819137022423
819137022461
819137024656

MANUAL INDEX

Manual Index	Page 5
Product Warning	Page 6
Key Features	Page 7
Product Contents	Page 8
Installation	Page 9
Powering and Setup	Page 11
Cleaning	Page 12
UIS™ Platform	Page 14
Connecting to Controllers	Page 15
Programming	Page 16
FAQ	Page 21
Other AC Infinity Products	Page 22
Warranty	Page 23

PRODUCT WARNING



TO REDUCE THE RISK OF FIRE, ELECTRIC SHOCK, OR INJURY TO PERSONS, OBSERVE THE FOLLOWING:

1. Ensure your power source conforms to the electrical requirements of this product.
2. Check your local code restrictions for additional safety measures that may be needed for a proper code compliant installation.
3. Read all instructions before installing and using this product.
4. If you are unfamiliar or have doubts about performing this product's installation, seek the services of a qualified, trained, and licensed professional. Inappropriate installation will void this product's warranty.
5. Do not attempt to hardwire this product. Performing any retrofitting actions may result in personal injury and/or electrical damage, and will void this product's warranty.
6. This product must not be used in potentially hazardous locations such as flammable, explosive, chemical-laden or wet atmospheres.
7. Do not cover power cords with rugs or other fabric materials.
8. This product has rotating parts. Safety precautions should be exercised during the installation, operation, and maintenance of this product.
9. Do not insert or allow fingers or foreign objects to enter through the fan grille as it may cause electric shock, fire, or damage to this product. Do not block or tamper with this product in any manner while it is in operation.
10. Do not depend on the on/off programming as the sole means of shutting power from this product. Unplug the power cord before installing, servicing, or moving this product.
11. Do not operate this product while its cord is damaged, or if it malfunctions, has been dropped, or is damaged in any manner.

KEY FEATURES

ADVANCED 35MM MOTOR

Re-engineered heavy-duty motor delivers precision oscillation quietly and efficiently with twice the lifespan of other clip fans.

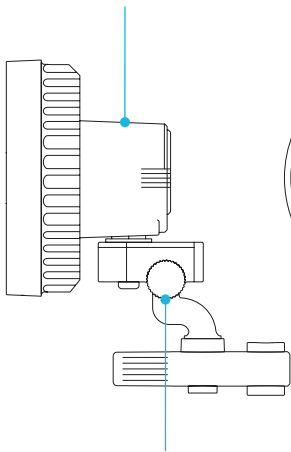

ADJUSTABLE RANGE

Flexible fan head tilts up 30° and downwards 40° to expand the scope of circulation and easily reach your desired height.

NEXT-GEN CONTROL

10 speeds and 10 Dynamic Wind Modes support natural airflow that can be adjusted to optimize each grow stage.

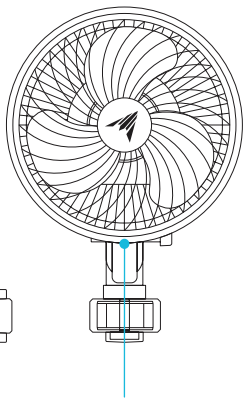

IP54 PROTECTION

Clip fan is specially sealed to Ingress Protection 54 standards, rated for a higher resistance to liquids and dust.

TARGETED AIRFLOW*

10 oscillation levels enable circulation to focus on a specific area or to cover the widest range possible without hitting tent walls.

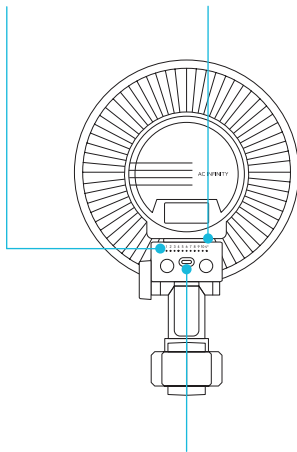

UIS™ COMPATIBLE

Pairs with UIS controllers for temp, humidity, timers, cycles, and scheduling plus WiFi app control.

*S-Series only

PRODUCT CONTENTS

CLOUDRAY A6, CLOUDRAY A9, CLOUDRAY S6, CLOUDRAY S9

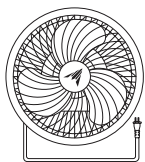

CIRCULATION
FAN
(x1)



GRIP
CLIP
(x1)

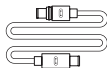

EXTENSION
CORD
(x1)



CABLE
TIE
(x4)

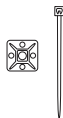

CABLE
MOUNT
(x1)

CLOUDRAY S6 - 2 Pack

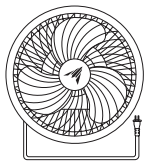

CIRCULATION
FAN
(x2)



GRIP
CLIP
(x2)

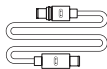

EXTENSION
CORD
(x2)



CABLE
TIE
(x8)

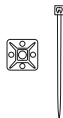

CABLE
MOUNT
(x2)

INSTALLATION

STEP 1

Twist to remove the knob piece from the grip clip.

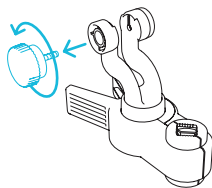

STEP 2

Slide the swivel into the grip clip.

You may need to pull its clamps apart for it to fit over the swivel. This tightness ensures that your fan will not tilt downwards on its own.

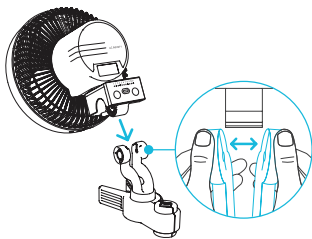

INSTALLATION NOTE

DO NOT alter the grip clip's neck positioning before connecting it to the swivel. The neck is packaged in the proper position so that your fan will not hit the tent pole.

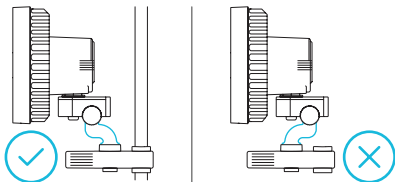

INSTALLATION

STEP 3

Replace the knob of the mounting point as desired.

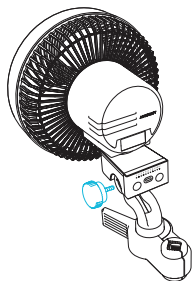

STEP 4

Clamp your clip fan onto a pole or post.

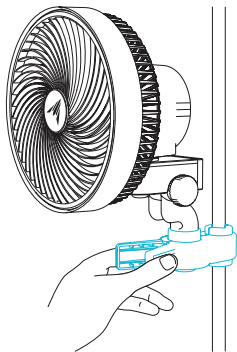

POWERING AND SETUP

STEP 1

Plug your clip fan's power cord into an AC power outlet to power it.

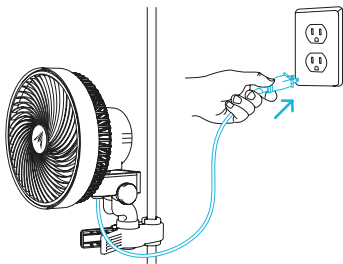

STEP 2

You may cable manage the cords using the included cable ties or cable mounting set.

Adhere the tie mount onto a clean surface. Loop the wire tie into the mount and around the cables.

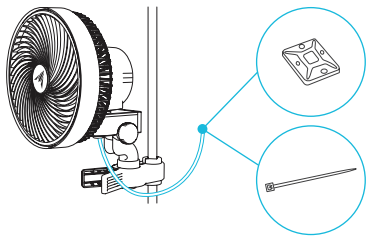

CLEANING

STEP 1

Unplug your clip fan.

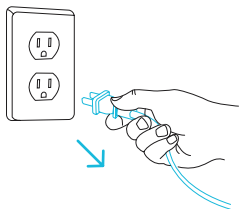

STEP 2

Unscrew the bottom of the front grille using a screwdriver.

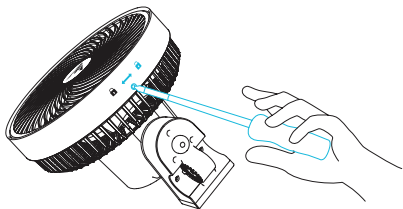

Removing the front grille to clean the fan blades will not void your warranty.

CLEANING

STEP 3

Twist the grille counter-clockwise and pull to remove it.

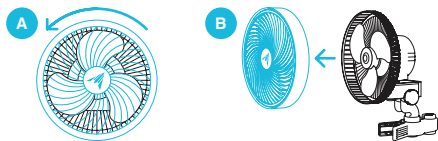

STEP 4

Wipe off any dust and debris from the grille and fan blades using a damp cloth. Set aside to dry as needed.

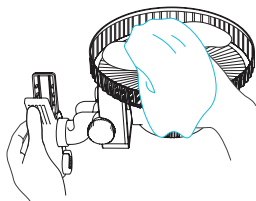

STEP 5

Realign the grille over your clip fan, twist clockwise, then screw the grille back on to lock it in place.

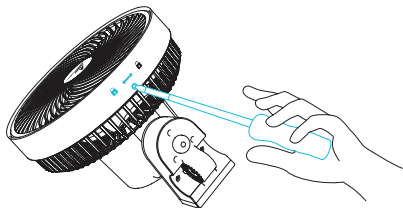

UIS™ PLATFORM

The UIS™ platform enables you to connect a single central controller with several grow devices simultaneously. By creating this fully integrated system, you can power and program all your devices together or separately for optimized grow tent management.

Your grow system can be regulated using your controller hub or remotely on the AC Infinity app (paired with compatible controllers), where you will have access to automation programming and climate data.

You can also connect your favorite grow light and outlet device to integrate them into the UIS platform using our RJ11/12 adapter and control plug module.

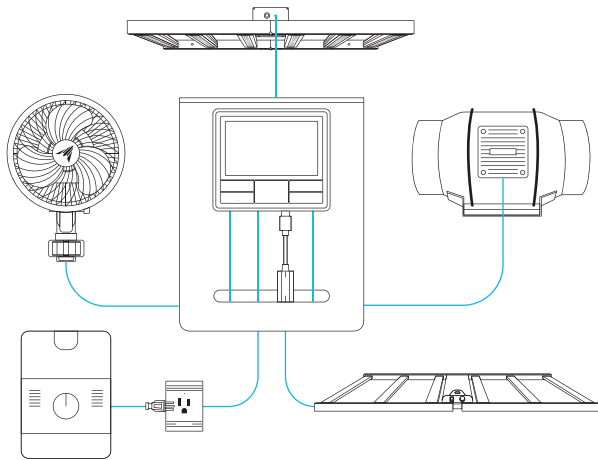

Central controllers, mounting plates, and grow devices will be sold separately and may still be in development at the time of your purchase of this product.

CONNECTING TO CONTROLLERS

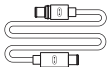

The CLOUDRAY circulation fan can connect with select smart controllers as part of an integrated system using the included UIS cable. [Please see below for limitations.](#)

STEP 1 — CONNECT TO DEVICE

Plug the UIS connector with the gasket end into your clip fan. The gasket is specially designed to protect against liquids and dust.

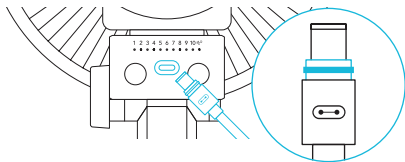

STEP 2 — CONNECT TO CONTROLLER

Plug the standard UIS connector into one of the controller's ports.

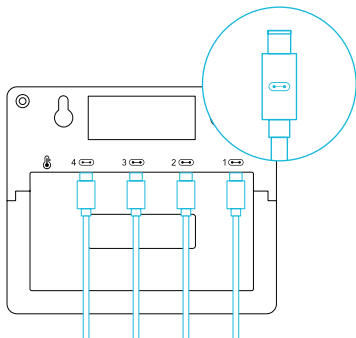

*CONTROLLER 69 PRO not included

PROGRAMMING

A-SERIES

POWERING ON/OFF

Press the power button to turn your clip fan OFF. Pressing it again from OFF will turn your fan ON at its last speed setting.

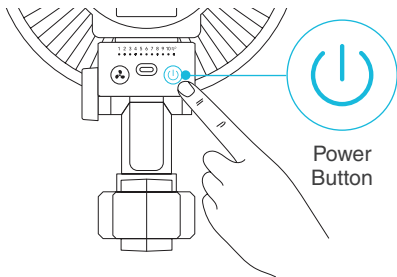

FAN SPEED ADJUSTING

The speed button cycles through fan speed levels 1-10, indicated by the row of white LED lights. Press the speed button to increase the fan speed level by one.

Cycling past speed 10 will activate Dynamic Wind Mode. Cycling past that will return to fan speed level 1.

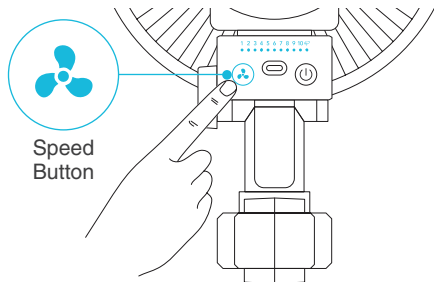

PROGRAMMING

A-SERIES

DYNAMIC WIND MODE

This mode will alternate speeds between levels 1-10 to simulate a natural breeze.

STEP 1

Set the fan speed to your desired maximum level using the speed button.

We do not recommend setting your max speed level to level 1; this will eliminate the speed range.

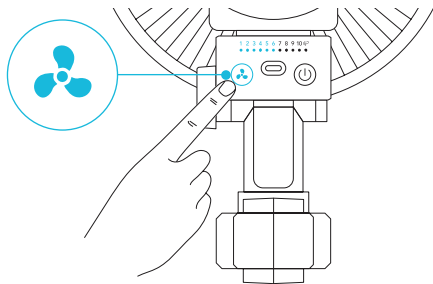

STEP 2

Hold the speed button for 3 or more seconds to enter Dynamic Wind Mode. This will also lock in your current fan speed as the maximum level.

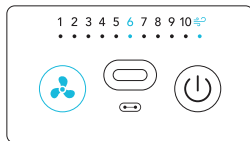

STEP 3

Deactivate max Dynamic Wind Mode by pressing the speed button.

Your clip fan will continue running at your maximum level until you adjust it.

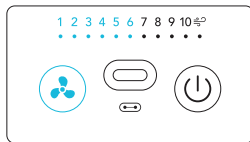

PROGRAMMING

S-SERIES

POWERING ON/OFF

Press the speed button to turn your clip fan ON. Cycling past Dynamic Wind Mode will turn your clip fan OFF.

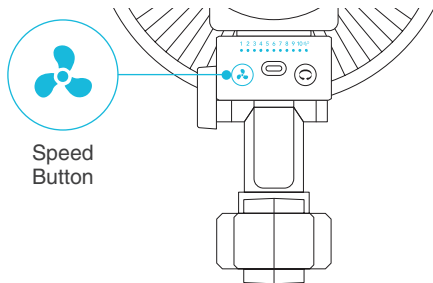

FAN SPEED ADJUSTING

The speed button cycles through OFF, fan speeds 1-10, indicated by the row of white LED lights. Press the speed button to increase the fan speed level by one.

Cycling past speed 10 will activate Dynamic Wind Mode. Cycling past that will return to fan speed level 0.

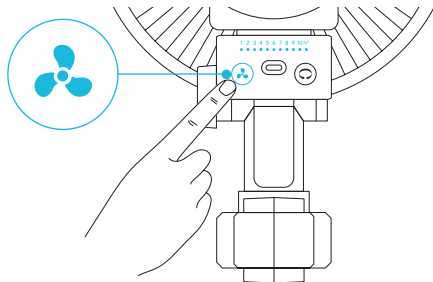

PROGRAMMING

S-SERIES

DYNAMIC WIND MODE

This mode will alternate speeds between levels 1-10 to simulate a natural breeze.

STEP 1

Set the fan speed to your desired maximum level using the speed button.

We do not recommend setting your max speed level to level 1; this will eliminate the speed range.

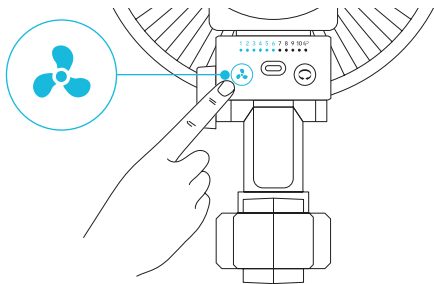

STEP 2

Hold the speed button for 3 or more seconds to enter Dynamic Wind Mode. This will also lock in your current fan speed as the maximum level.

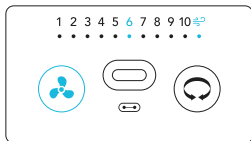

STEP 3

Deactivate max Dynamic Wind Mode by pressing the speed button.

Your clip fan will continue running at your maximum level until you adjust it.

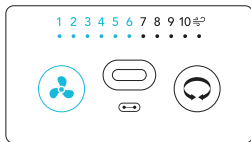

PROGRAMMING

S-SERIES

OSCILLATION

In addition to the standard features, S-Series models can oscillate to provide airflow at a wide angle. The oscillation function is manually activated using the oscillation button and cannot be controlled using external UIS programming.

If set to OFF, your clip fan will not oscillate regardless of any external programs.

If set to ON, oscillation will automatically start if the external program activates your clip fan to turn ON. Oscillation will then automatically stop if the external program deactivates your clip fan to turn OFF.

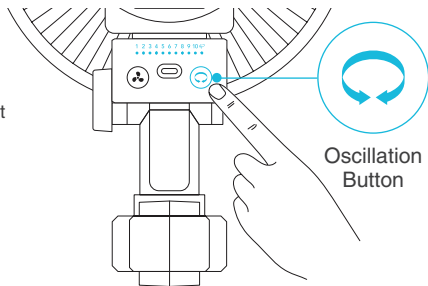

ADJUSTING OSCILLATION RANGE

The oscillation button cycles through oscillation levels 0-10 with a maximum 90° angle range. This will ensure that your clip fan will not come into contact with your grow tent while still enabling you to adjust the focus of circulation.

Press the oscillation button to increase how wide your clip fan will oscillate by one level. These levels are indicated by the orange row of LED lights.

Pressing the button past speed 10 will return to level 0.

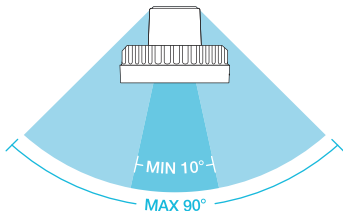

CLOUDRAY FAQ

Q: Can I mount this clip fan upside down?

A: No. We do not recommend mounting the fan upside down.

Q: Will I be able to hardwire this clip fan to my own controller or thermostat?

A: We do not recommend hardwiring or splicing our fan's power wires. Such modifications may compromise electrical safety and will void this product's warranty.

Q: Do I need to use a power converter if I'm outside the US?

A: This product's voltage range is 100-240V AC. You may need a simple travel adapter to plug it into a foreign socket, or a power converter if your country uses a different voltage.

Q: What is the CFM of my clip fan?

A: Please refer to your CLOUDRAY model's product listing for its CFM specification.

Q: Will the clamp be able to hold onto my grow tent?

A: The heavy-duty clamp is capable of gripping onto the poles of any thickness in any grow tent.

Q: Will I be able to connect additional units to this clip fan?

A: The CLOUDRAY does not support daisy-chaining or interconnectivity between additional clip fans. However, multiple fans can be connected to a UIS™ controller to receive smart programming.

Q: How long can I keep this clip fan running?

A: The CLOUDRAY features the latest innovations in step motor technology, allowing it to run continuously for 24 hours a day.

AC INFINITY PRODUCTS

Inline Duct Fans

The CLOUDLINE series is a line of duct fans designed to quietly ventilate AV rooms and closets, as well as various DIY air circulation and exhaust projects. Features a thermal controller with intelligent programming that will automatically adjust duct fan speeds in response to changing temperatures.

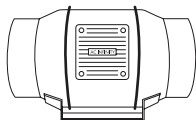

Advance Grow Tents

The CLOUDLAB series is a line of grow tents designed to create ideal growing conditions and facilitate indoor plant cultivation year-round. Features 2000D thick Oxford canvas lined with inner diamond patterned mylar that maximizes grow light luminosity, and a reinforced frame with 150 lb. weight capacity.

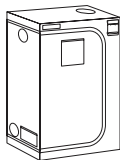

Grow Lights

A commercial level LED grow lamp designed to simulate outdoor daytime lighting with a richer light spectrum. Using the latest Samsung LM301H EVO diodes for unmatched intensity and efficacy, this LED grow system efficiently produces full-spectrum lighting to enhance all stages of the grow cycle.

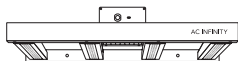

Discover the latest innovations in environmental controls at acinfinity.com

WARRANTY

This warranty program is our commitment to you, the product sold by AC Infinity will be free from defects in manufacturing for a period of two years from the date of purchase. If a product is found to have a defect in material or workmanship, we will take the appropriate actions defined in this warranty to resolve any issues.

The warranty program applies to any order, purchase, receipt, or use of any products sold by AC Infinity or our authorized dealerships. The program covers products that have become defective, malfunctioned, or expressively if the product becomes unusable. The warranty program goes into effect on the date of purchase. The program will expire two years from the date of purchase. If your product becomes defective during that period, AC Infinity will replace your product with a new one or issue you a full refund.

The warranty program does not cover abuse or misuse. This includes physical damage, submersion of the product in water, incorrect installation such as wrong voltage input, and misuse for any reason other than intended purposes. AC Infinity is not responsible for consequential loss or incidental damages of any nature caused by the product. We will not warrant damage from normal wear such as scratches and dings.

Contact our dealers department at dealers@acinfinity.com or (626) 838-4656 for more information about our dealers and distributors program. Contact our customer service department at support@acinfinity.com or 626-923-6399 for product and warranty assistance. Our business hours are Monday through Friday, 9:00 am to 5:00 pm PST.



If you have any issues with this product, contact us and we'll happily resolve your problem or issue a full refund!

COPYRIGHT © 2024 AC INFINITY INC. ALL RIGHTS RESERVED

No part of the materials including graphics or logos available in this booklet may be copied, photocopied, reproduced, translated or reduced to any electronic medium or machine readable form, in whole or in part, without specific permission from AC Infinity Inc.

www.acinfinity.com